

USER'S MANUAL



TABLE OF CONTENTS

WELCOME	<i>About this Manual, The help function</i>	5
THE FRONT PANEL	<i>Keys, LED's and other functions explained</i>	6
THE REAR PANEL	<i>Inputs, Outputs</i>	8
THE SIGNAL FLOW		9
RECALL	<i>SNAPSHOTS, Recalling a Preset, Combined recall, Factory/User presets, Memory card</i>	10
STORE	<i>Store a new preset, The letterbox, Combined store</i>	12
THE WIZARD		13
I/O MENU	<i>I/O, Input selector, Sample Rate, Mix, Primary output</i>	14
LEVELS MENU	<i>Ranges, Auto level</i>	15
ROUTING	<i>Serial, Parallel, Dual input, Dual mono, Stereo, Preset glide, Studio setup examples</i>	16
UTIL/MIDI	<i>Display, Preset glide, MIDI in, MIDI out, MIDI map, Security, Memory protect, Backup, Pedal</i>	18
TEMPO MENU	<i>Tap key, BPM, Tempo subdivisions.</i>	20
MIDI MONITOR		21
TUNER		21
EDIT	<i>Combined Edit, Engine output level</i>	22
DYNAMIC MORPHING		23
THE PROGRAMS	<i>Reverb, Chorus, Flanger, Delay, Phaser, Pitch, EQ, Tremolo, Stereo, Dynamic</i>	24
THE RESET PAGE	<i>Reset page, User data page</i>	30
TECHNICAL REFERENCE		31
TROUBLESHOOTING	<i>Maybe you will find help here</i>	32
MIDI IMPLEMENTATION CHART		33
SELF-TEST PROGRAM		34
GLOSSARY		35
PRESET LIST		36

WELCOME

Congratulations on the purchase of your new M2000. We hope, that you will have as much pleasure using it as we had making it.

The M2000 is basically two separate effect Engines housed in the same box. They can be used as such but they can also work together in a number of Combined configurations. The outputs of the two Engines are mixed down to a common stereo output. The general Control of the M2000 is accomplished by moving the cursor with the cursor keys; value changes are made by turning the Adjust wheel.

The rest is simple. You select the area that you wish to control by pressing the function keys on the front of the M2000; i.e., if you want to Recall you press the RECALL key.

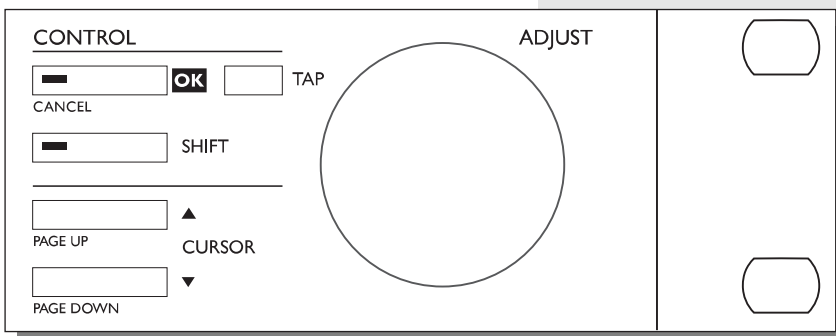

About this Manual

Many people in the music business have an aversion to reading manuals. We understand that. So if you feel like starting without reading the whole manual, simply: Plug & Play. You can always use the manual for checking out areas that you have questions about or if you want to dig deeper into the unit. Refer to the Table of Contents for further information.

On the other hand, you might want to know a little more about the M2000 before you start pressing keys. The manual will take you step by step through all of the M2000 functions. If you want to read about a specific function, please refer to the Table of Contents.

The Help function

The Help function is another way to learn your way around the M2000. Simply press Help (Shift - I/O) and the Help function will brief you about functions in the current display.

THE FRONT PANEL

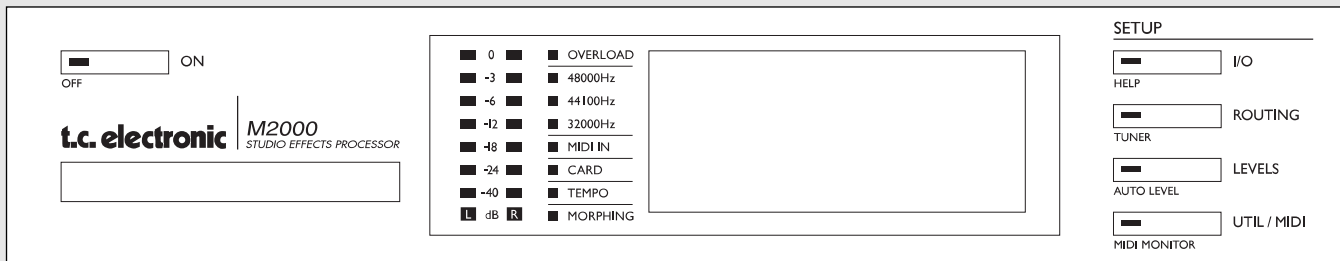

POWER + MEMORY CARD

Electronic power switch
»Easy touch«
Keep pressed for more than 1sec to turn device off.

PC-CARD memory card
Copy presets to/from a standard memory card.

PPM + INDICATORS

PPM meters
range from -40dB to 0dB

Overload
Lights up if internal overload occurs.

SampleRate indicator
48000Hz
44100Hz
32000Hz

Midi In
Midi receive indicator

Card
Indicates presence of a valid memory card

Tempo
Beats per Minute indicator

Morphing
Indicates an on-going morphing

SETUP SECTION

I/O
Input/output
Samplerate
Digital/analog selection
Dithering.

Routing
Setup the internal routing of the 2 engines.

Levels
Input/output analog levels
Digital input level

Util/Midi
Viewing angle
Security lock
Preset handling
Pedal input
MIDI

Secondary functions
Help (online help function)
Tuner (the tuner you always wanted)
Auto level (the fast way to set input levels)
Midi monitor (Monitors all midi ch. at the same time)

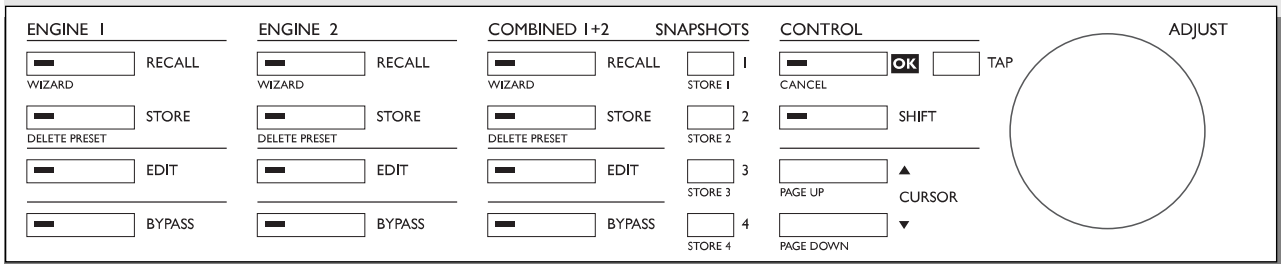

ENGINE 1 OR 2

Recall
Recall presets to engines

Store
Store and name presets.

Edit
Edit engine 1 or 2

Bypass
Individual bypass key for each engine.

Second functions
Recall Wizard
Find a preset that match your application
Delete Preset
The fast (and only) way to delete presets

COMBINED 1+2

Recall
Recall combined presets.

Store
Store and name combined presets

Edit
Engine mix level
Dynamic Morphing

Bypass
Bypasses the entire device.

Snapshots 1-4
Quick store/recall of combined presets

Second functions
Recall Wizard
Delete Preset

CONTROL SECTION

OK
Confirms operations.

Shift
Enables access to »shifted« secondary functions.

Cursors
Moves between parameters

Adjust wheel
Sets parameter values and preset numbers.

Second functions
Cancel
Page up/down

THE REAR PANEL

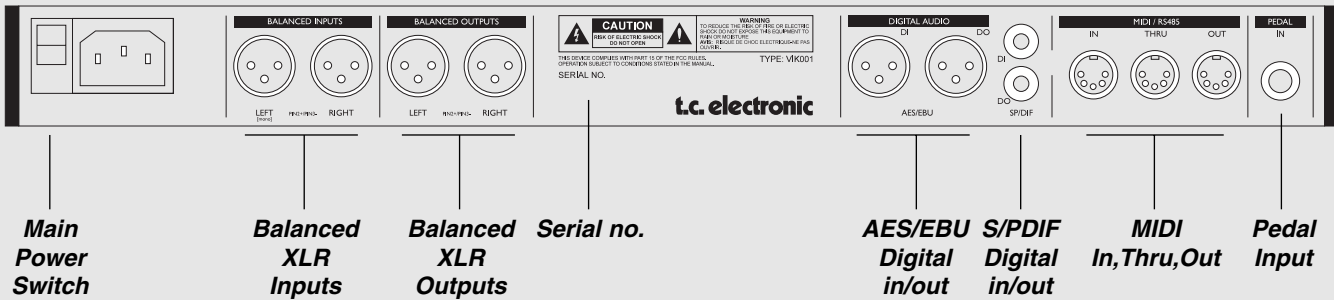

Notes:

To accommodate International regulations, we have also added a back panel power switch. You don't need to use the power switch on the rear panel. Use the front panel power switch instead.

Remember to use the left input when you're using only one input.

Pin 2 is »hot« on all XLR's (AES Regulations).

If You are connecting the M2000 to unbalanced equipment, you must tie pins 1 and 3 together in the cable ends away from the M2000.

We have reserved the two unused pins on the MIDI connectors for an optional RS485 interface. Therefore, if you are connecting M2000 to other equipment that use these pins, please make sure the cable is a 3-wire standard MIDI type, and not a five wire MIDIPLUS type.

If you want to use the pedal input, be sure it is a momentary »make« type.

THE SIGNAL FLOW

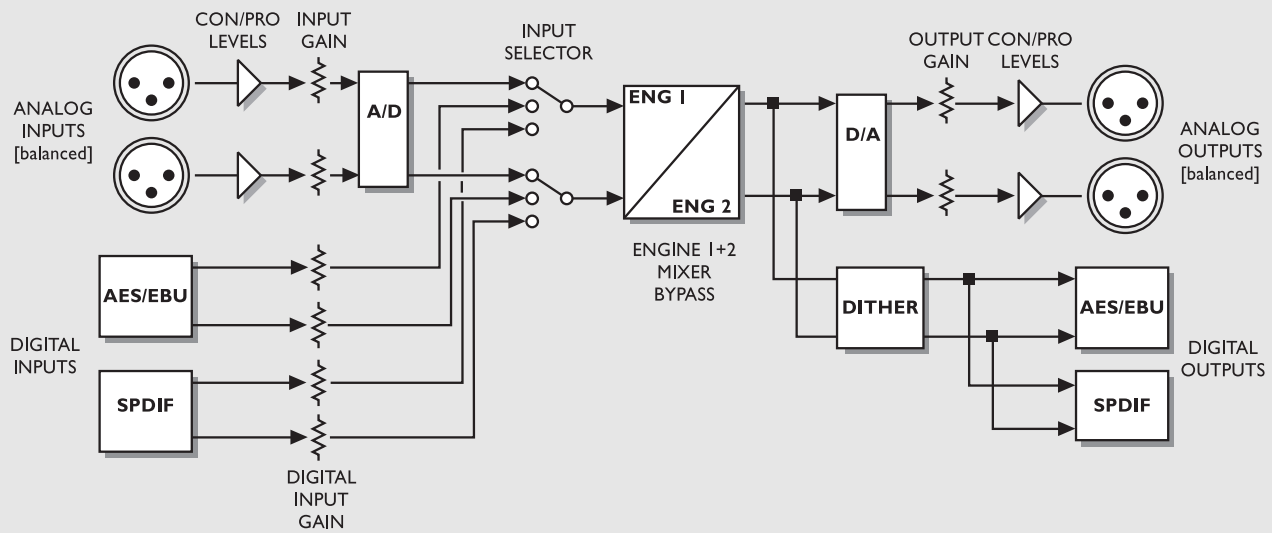

Notes Regarding the signal flow:

As shown in the block diagram signals are present on all outputs, all the time.

The digital input gain circuit is capable of »lifting« the signal level. This is a very useful feature if you e.g. are feeding the M2000 with a DAT recording that isn't fully leveled to 0 dB.

RECALL + SNAPSHOTS

The Recall Displays

The Recall display is the »homepage« of the M2000. This means that you return to this display whenever you exit any other display of the M2000.

The Recall display is split into two halves, showing the presets of both Engines at the same time. Engine 1 is always the top half while Engine 2 is the bottom half of the display.

If you want to have only one effect, use one engine and set the other in bypass mode.

Recall Display

	Algorithm type	Primary parameter	Edited flag	Preset number	Bank indicator (RAM/ROM)
Engine 1	1 TYPE PLATES	DECAY 2.85s	E	120	RAM
	Stonewall				
Engine 2	2 TYPE DELAY	TIME 25ms	E	20	RAM
	Another one				

Combined Recall Display

Primary parameters		Edited flag	Preset number	Bank indicator (RAM/ROM)
1: TIME 25ms	2: DECAY 2.85s	E	20	RAM
Another one				
Routing mode diagram showing two paths (L and R) crossing, labeled 'PARALLEL'.				

Flag indicating change to a new routing (only visible during preset preview)

Recalling a Preset

When you wish to Recall a preset, simply use the ADJUST wheel to scroll through the presets and press OK to Recall.

Another way of Recalling is to use the Wizard described later in this section (see »The Wizard«). The Preset number and the OK key will be blinking while you are previewing, indicating that the shown preset is not Recalled yet.

Use the Cursor keys (or the other Recall key) to access the other Engine.

Combined Recall

The M2000 is capable of Recalling Combined presets, meaning a preset for each Engine in a combination.

A Combined preset consists of two normal presets and the Routing of the M2000: i.e. by Recalling Combined preset 30, a Chorus will be loaded into Engine 1; a Reverb will be loaded into Engine 2, and the Routing will change to Serial (see »Routing«).

To Recall a Combined preset:

Press the Combined Recall key and scroll through the presets using the Adjust wheel. Press OK when you find the right preset.

The Preset number and the OK key will be blinking while you are previewing, indicating that the shown preset is not Recalled yet.

A Combined preset is made out of two normal presets. This means that when you return to the normal Recall display (the Homepage) the M2000 will display the numbers and names of the two presets that the Combined preset consists of. The Edited flag will light if the presets have been modified.

Factory/User Presets

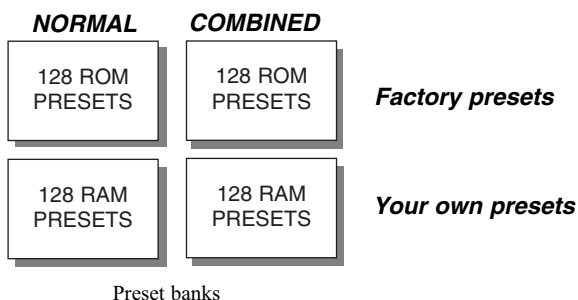

The M2000 contains four different preset banks. Each bank can hold 128 presets.

The four banks are as follows:

Normal ROM bank:

This bank contains 128 normal factory presets. The presets are available from Engine 1 and Engine 2.

Combined ROM bank:

The Combined bank contains 128 Combined factory presets. The

presets are available from the Combined Recall.

Normal RAM bank:

This bank can hold up to 128 of your normal presets.

Combined RAM bank:

The Combined Ram bank can hold up to 128 of your Combined presets (see Combined presets).

The two Ram preset banks are located after the corresponding Rom banks. This means that you scroll through the 128 Rom presets to enter the Ram bank.



For fast RAM access press shift and turn Adjust wheel one click to the right.

Snapshots

The Snapshots are fast Recall keys. Store your favorite presets or use the Snapshots as four compare keys.



A Snapshot will always include both Presets, and Routing just like a Combined preset.

With the Snapshots you are able to switch between completely different configurations with the touch of a single key.

TAKING A SNAPSHOT:

When you want to Take a Snapshot of your M2000 setup, press Shift and the Snapshot key where you want to store.

RECALLING A SNAPSHOT:

Recall of a Snapshot is very easy as well: Simply press the Snapshot you wish to Recall and the M2000 will change the whole setup.

STORE

Store a new RAM Preset

- Press the **STORE** button [Engine 1, 2 or combined]
- Select a location for your new preset [dial between preset 1 to 128]
- Move cursor to the new name line and dial in the new preset name [find letter with ADJUST and confirm with OK]
- Point on **DONE** and press OK to finalize store operation.

Store with the same name:

If you want to Store the Preset with the existing name simply select the RAM location to Store in by using the ADJUST wheel and press OK (the OK key will be blinking while you search for a suitable RAM space). The M2000 will now tell you "STORED" in a pop-up window and return to the homepage.

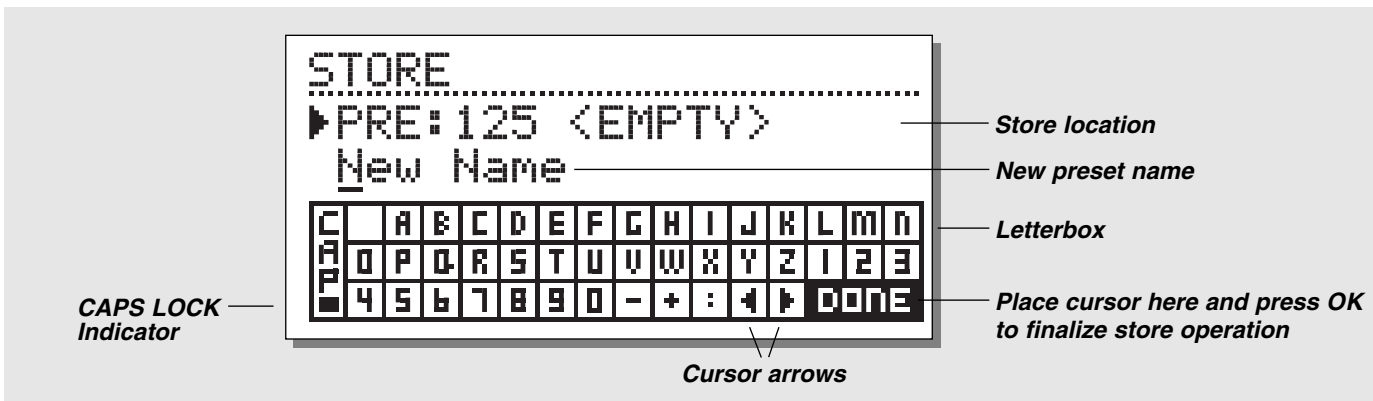

The letterbox

When you want to change the name of the preset to Store, press the Cursor Down key. You are now able to write a new name using the letterbox. Simply dial the ADJUST wheel and press OK to select new letters.

Select CAP, by pressing OK, to change case.

When you have changed the name select DONE in the Letterbox and press OK to Store.

Combined Store

The handling of Combined Store is exactly the same as a normal Store.

Please note that a Combined Preset Stores the Routing of the Engines along with the Preset.

Using a Memory Card:

When you wish to use a Memory card, simply insert the Card in the M2000. The M2000 will now autodetect your card and the Store, Recall and Snapshot facilities will be attached to the Memory card. The M2000 will now use the Memory Card as a normal RAM bank. When you remove your Memory card the M2000 will switch back to the internal RAM.

If the format of the Memory card is not correct, the M2000 will detect this immediately.

Card types

Type 1 PC-CARDS, with minimum 64KBytes SRAM.

THE WIZARD

The Wizard is a tool that helps you find the right preset for your program material.

The Wizard is easy to access and simple to use.

Try it out, and listen what our creative staff suggests for your program material.

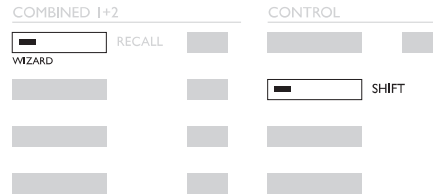

How to enter »The Wizard«

The Wizard Display

Engine 1 or 2

1. Select the type of effect you want

2. Which instrument to be used on

3. and the category of intensity

Dial here to select between presets that utilize the search criteria.



Number of presets utilizing the search criteria

Name of selected preset

Press Shift and Wizard to enter the function
Use the parameter keys to select the different filters and the Adjust wheel to select filter parameters.

Set the three different categories as you desire and try out the proposed presets. The Wizard will show the Name and Number of the proposed preset.

Scroll through the Presets using the Adjust wheel and press OK to Recall.

You can use the Wizard in many different ways, i.e., set it to enter only Drum Reverbs or use it as a creative partner.

Algorithm types

- Reverb
- Delay
- Chorus (including flanging and phasing)
- Pitch
- Dynamic (compressor/limiting/expanding/deessing)
- Misc.

Instruments

- Vocals
- Guitars
- Bass
- Keyboards
- Percussion
- Classic instruments (violins, flutes, etc.)

Category

- Gentle
- Normal
- Extra

I/O

Press the I/O key to setup various I/O parameters.
Move the marker using the Cursor keys and turn the ADJUST wheel to change values.

The screenshot shows the I/O menu with the following settings: INPUT: ANA SP/DIF AES; MIX: MIX 100%; STATUS BIT: SP/DIF AES; DITHER TO 16 BIT. Annotations point to the Input Selector (ANA), Input Signal (LEFT), Sample rate (44.1), and the Mix 100% setting.

Input Selector — **ANA** SP/DIF AES

Input Signal — LEFT BOTH

Sample rate: 44.1 48.0 DI

MIX: MIX 100%

STATUS BIT: SP/DIF AES

DITHER TO 16 BIT

Here you can freeze mix to 100%

Select Status Bit output: SP/DIF OR AES/EBU standard.

Indicates the number of bits digital output are dithered to. Automatically set to default value, when changing Status Bit.

I/O

Press the I/O key to setup various I/O parameters.
Move the marker using the Cursor keys and turn the ADJUST wheel to change values.

Input

Select Input source Analog/Digital.
Select Input type Left/Both. When you select *Left* the right input will be muted. If you are using two inputs you should select *Both*

Sample rate

Select Master clock 44.1 kHz/48 kHz/DI.
When Digital Input is selected, the external Clock frequency will be displayed by the three LEDs on the left side of the Display. If the M2000 cannot lock, all three LED's will be blinking.

Mix

The Mix is a global parameter. When Mix is set to "100%" the Mix parameter of all presets will be 100% and no direct signal will pass through the M2000. Note that when Mix is set to 100% the Bypass keys will act like Mute-keys.
When Mix is set to "Mix", the parameter is adjustable.

Status Bit:

This selector changes the Channel Status Bits of the digital output between professional and consumer format. When AES is selected, the M2000 will output the professional AES/EBU standard, and when S/PDIF is selected, the M2000 will output the S/PDIF consumer standard.

The defaults setting is AES/EBU but some digital consumer products refuses to accept the professional standard.
In that case change to S/PDIF consumer standard.

Example: If you are using a non-professional DAT machine as a receiver of the M2000 digital output, and you cannot make it accept the digital input, change the output format from AES/EBU to S/PDIF.

NOTE: The different Status Bit standards do not affect the quality of the audio output from the M2000.

Dither:

The M2000 can output Dither from 8 to 22 bit resolution on the AES/EBU and S/PDIF output. The dither type is HP-TDF or High Pass Triangular probability Density Function.

M2000 uses internal 24 bit resolution and 24 bit AD/DA converters. Dither should therefore only be used when the digital outputs are used (e.g. to a 16 bit DAT machine). It is recommended not to use dither until the final stage of a production, so if there is a chance that the source material is going to be dithered later in a production, do not use Dither.

LEVEL MENU

Press the Level key to access this menu.

These global level controls should be set to optimize the performance of the 24bit AD converter in the M2000.

The Level bars can be controlled individually or in common.

Mark the level bar you want to control using the cursor keys, and turn ADJUST to change value.

For common control the marker should be set between the two Level bars.

Note that the Digital In Level is capable of +6 dB gain.

LEVELS

Section	Mode	L Level	R Level
INPUT: CON: -10dBu	L	-10 dB	-10 dB
	R	+16 dB	+16 dB
OUTPUT: PRO: +6dBu	L	-16 dB	-16 dB
	R	+4 dB	+4 dB
DIGITAL IN		+6 dB	+6 dB

Place cursor between L and R to adjust simultaneously

Ranges

Analog Inputs

Consumer range: -16dB to +10dB

Professional range: -6dB to +16dB

Analog Outputs

Consumer range: -10dB to +16dB

Professional range: -16dB to +6dB

Digital Input Level

Adjust the Digital Input from: Off to +6dB.

Auto level

Press SHIFT and AUTO LEVEL to activate function.

SETUP	ENGINE 1
I/O	RECALL
HELP	WIZARD
ROUTING	STORE
TUNER	QUICK STORE
LEVELS	EDIT
AUTO LEVEL	
UTIL / MIDI	BYPASS
MIDI MONITOR	MUTE 2

Send your expected source into the M2000 and press Auto Level (Shift-Levels) to optimize your Input level automatically. The M2000 will perform a measure for about five seconds and then adjust the Input level giving you about 6 dB of headroom.

ROUTING

Pressing the Routing key gives you the ability to choose one of six different Routings. Move the marker by pressing the Cursor keys and press OK to accept the new Routing. A small pop-up window will tell you that the Routing has changed.

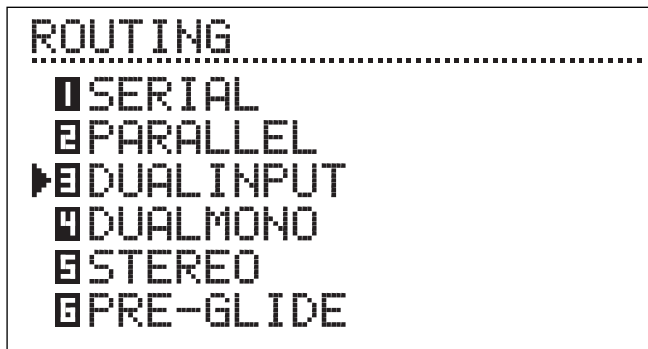
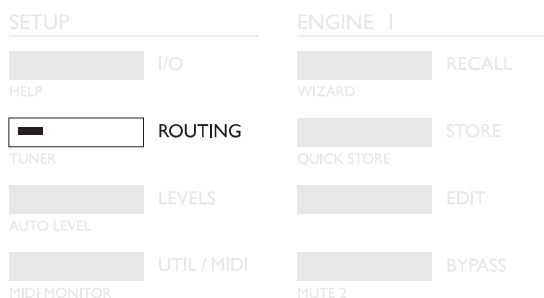

Serial



The Serial mode is a Stereo In/Out Routing. The Serial mode is very useful when you want two independent effects in the same signal path; i.e., from a

Keyboard through the M2000 Reverb and Chorus to The mixer.

Parallel



The Parallel mode is a stereo In/Out Routing. Both Engines will work as stereo effects and their Output will be mixed

down to a stereo signal. With this Routing, the M2000 can be used as two parallel effects on the same stereo source. You may also set the I/O menu to left input to get two independent stereo-out effects on the M2000 from a single send on the mixer.

Dual input (Split mode)



The Dual input mode is a Dual mono In / stereo Out Routing. Left In is always attached to ENGINE 1 and Right In is

attached to ENGINE 2. Using this Routing enables you to get two different effects with separated inputs; i.e., connect Aux 1 from your Mixer to Left In and Aux 2 to Right In. You now have access to two separate effects with a common stereo output. Set the individual Preset output volumes to achieve the correct effects balance.

Dual Mono



This mode is for Dual Mono In/Out Routing. Left In/Out is always ENGINE 1 and Right In/Out is ENGINE 2. The Dual Mono is very useful when you want to

use the M2000 as two independent Inserts.

Stereo



When you select the Stereo Routing, the two Engines will link together to perform true Stereo. This means that the preset of Engine 1 will be copied into Engine 2 and the Edit pages will lock together. The Stereo Routing is indicated by the two Edit LEDs which will be lit simultaneously. Left and Right channel audio path are completely separated in this Routing.

Preset Glide



When the Preset Glide Routing is selected, the M2000 will perform preset changes by crossfading the current Effect and the new preset. This gives you a very

smooth change of effects; i.e., allowing a Delay to keep repeating while a Chorus is being faded in.

The glide time is located in the Utility menu (see Util/MIDI).

Please note that only one Engine is available while the M2000 is in the Preset Glide Mode.

STUDIO SETUP EXAMPLES

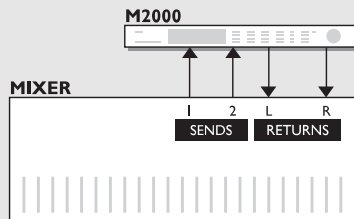

Use two sends on your mixing console

Dual Input mode

Let's say Engine 1 is running a long Hall-type reverb and Engine 2 a short more ambient type of reverb. On Your mixing console you'll now have individual sends for the two effects. And - not to forget - you are saving a set of return channels.

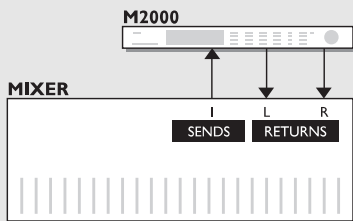

Create your own vocal reverb

Serial mode

You probably always wanted to have a long bright reverb on your lead vocal, without »esses« hanging for seconds. That's now possible. You simply connect a »de'esser« and your favorite reverb in serial. The de'esser will cut away all sharp transients in the signal.

If you want your vocal to have a unique »livingness«, or the reverberated signal to be slightly detuned, simply connect the pitch shifter or chorus in series with the reverb.

There are numerous applications in this mode - try them out.

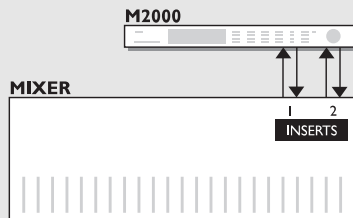

Two individual inserts on your mixer

Dual mono mode

In the dual mono mode you are able to use two completely separate mono effects at the same time. It can be equalizers or compressors or whatever you can imagine.

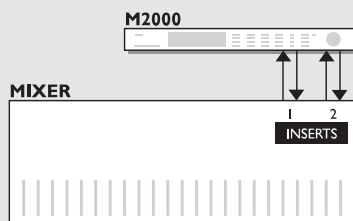

Post Production

Stereo mode

When running in stereo mode both engines are linked in stereo and both channels audio path are totally separated. This means that you can process Dolby Surround™ materials without destroying the hidden information. Use this mode when adding reverb to your recording.

UTIL/MIDI

```
UTIL/MIDI..... [ENG.1] ENG.2 COMB
DISPLAY:
VIEWING ANGLE: —|—
PRESET GLIDE:
Glide time : 0.5s
MIDI INPUT:
Channel : 1 2 16
Filter : PROG.ONLY
Pr9Offset: 0 0 -1
Pr9Bank : Ram Ram Ram
SysEx ID : 75
MIDI OUTPUT:
Channel : 1 2 3
Filter : PROG.ONLY
Pr9Offset: 0 0 0
MIDI PROGRAM MAPPING:
Mapping : off off off
ProgramIN: 25
maps to: 1 2 3
Reset Map: [OK] [OK] [OK]
SECURITY:
Security Lock: [PRESS OK]
Your PIN-CODE: 0025
MEMORY PROTECT:
Protect : off
Protect LOLIM: 0
Protect HILIM: 0
Snapshots : off
MEMORY BACKUP:
MEM to CARD : [PRESS OK]
CARD to MEM : [PRESS OK]
MEM to MIDI : [PRESS OK]
MIDI to MEM : [PRESS OK]
PEDAL:
Pedal will do: BYPAS1
```

How to move around

In the Util/MIDI menu you always move by pressing the Cursor keys and change values by dialing the Adjust wheel.

Display

Viewing Angle:

Adjust for best contrast on the LCD display.

Preset glide:

Glide time

This parameter sets the glide time of the incoming preset. The parameter is only active when Preset glide Routing is selected (See Routing).

In the MIDI section you are able to see the MIDI setup of both Engine 1, Engine 2 and the Combined section at the same time.

MIDI In

Channel

Sets the Channel of which the current Engine will respond to. When set to Omni the Engine will respond to all channels, When set to off no MIDI will be received.

Filter

Sets whether the current section of the M2000 should respond to MIDI Control changes (CTRL) and MIDI Program changes (PROG) or not; i.e., when Filter is set to PROG the M2000 will only respond to MIDI Program changes.

Offset

With this parameter, you are able to add or subtract to the incoming Program change; i.e., the incoming Program Change is preset 123, and the Offset is set to +1, the Program Change will now be 124.

Sys-ex id

Sets the Sys-Ex ID number of the M2000.

MIDI Out

Channel

Sets the sending MIDI channel of the M2000.

Filter

Sets whether the current section of the M2000 should send out MIDI Control changes (CTRL) and MIDI Program changes (PROG) or not; i.e., when Filter is set to PROG the M2000 will only send out MIDI Program changes.

Offset

With this parameter you are able to add or subtract to the outgoing Program change; i.e., the outgoing Program Change is preset 123, and the Offset is set to +1 the Program Change will now be 124.

MIDI Map

MIDI Map

Sets the current MIDI Map On or Off.

Prg. Bank

Determines which Bank the MIDI Map should control; Ram/Rom.

Prg. In

The current Program change Maps to a M2000 program (See Maps to).

Maps to

The current incoming Program change set in "Prg. In" will be changed to the Program number of this parameter.

Reset Map

Press OK while this parameter is selected and your MIDI Map will be Reset.

Security

Security Lock

Press OK while this parameter is selected to Security lock the M2000. When locked, you will have to dial the PIN-Code shown below to access the M2000.

PIN-Code

Set your own PIN-code for the Security lock by Dialing the Adjust Wheel.

If you should forget your PIN-code, please enter the Reset page. This will release M2000 from the locked state. (You do not have to run any of the reset functions).

Memory Protect

Protect

This parameter sets the Memory protect On or Off. When the Protect is activated the Ram presets inside the High and Low limit are write protected.

Low Lim

Sets the Low limit of the Memory protect. The current number is included in the Protect.

High Lim

Sets the High limit of the Memory protect. The current number is included in the Protect.

Snapshot Protect

Enables or disables the Protect of the Snapshots. When activated the Snapshots are write protected.

Memory Backup

Mem > Card

Insert a PC-CARD Card in the card-slot and press OK. All Ram presets of the M2000 will now be backed up to the Memory Card.

Card > Mem

Insert the PC-CARD Card containing your presets and press OK. All Presets will now be Stored back into the M2000 Ram.

Warning:

This action will destroy ALL existing Ram Presets of the M2000.

Mem > Midi

Connect your M2000s Midi Out to a another M2000, a Sequencer or any other Midi Recordable device. Press OK and the M2000 will perform a Midi bulk dump of all Ram Presets.

Midi > Mem

Connect the Storing device to the M2000s Midi In and press OK. The M2000 is now ready to receive a Midi bulk dump containing Ram presets. WARNING this action will destroy ALL existing Ram Presets of the M2000.

Pedal

Pedal

The Pedal input can control any one of four different features: Engine 1 Bypass, Engine 2 Bypass, Engine 1+2 Bypass and Tap tempo.

Select by turning the Adjust Wheel.

TEMPO

Tapped or dialed BPM

Which engine to work on

Define subdivision beat

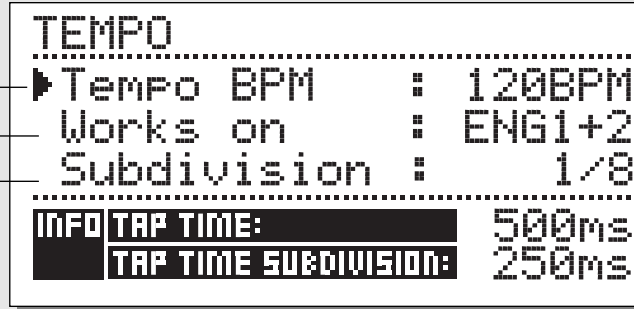

Tapped time in ms.

Tapped time in ms.
corrected with
the subdivision factor.

Tap Tempo

The Tap Tempo key is similar to its cousin “Learn” on the TC 2290 Digital Delay. Only the M2000 Tap Tempo key can control various parameters: Delay time, Decay time, Chorus speed, etc. When you press the Tap key, a Tempo menu pops up. If no further actions are made, the Tempo menu will disappear after a few seconds.

The Tap key is attached to a default parameter in each effect type. This means that the function of the Tap key changes along with the presets (See default list later in this section).

The Tempo Menu

The Tempo you tap is always measured in BPM (Beats Per Minute). The Tempo menu is able to recalculate the tapped time into Subdivisions of the BPM. Simply set the Tempo menu to the Subdivision you like and Tap the BPM on the Tap Tempo key. You also have the possibility of changing the Tempo using the BPM parameter in the Tempo menu. When a preset has been “Tapped”, the parameter attached to the Tap function will be displayed in BPM in the Tempo Menu.

Tempo BPM

The BPM will display the Tapped tempo (BPM is equal to the 1/4 Subdivision). You can also set your Tempo with this parameter using the ADJUST wheel.

Subdivision

Sets the subdivision of the Tempo. If the Subdivision is set to 1/8, the actual Tempo will be twice as fast as the tapped time, etc. The following subdivisions are possible:

1, 1/2, 1/4, 1/4T, 1/8, 1/8T, 1/16, 1/16T, 1/32, 1/32T (T for triplets).

Tap/Subdivision

This is read only parameters displaying the tapped time and the Subdivided time in milliseconds. Tap Time Subdivision is corresponding to the parameter in your preset.

The parameters controlled by the Tap key

Reverb Decay parameter

Delay Delay time

Chorus Speed

Flanger Speed

Phaser Speed

Tremolo Speed

Panner Speed



Press and hold TAP for 3 seconds to learn MIDI tempo (MIDI-Clock).

MIDI MONITOR & TUNER

»MIDI MONITOR SCREEN«

- Program changes
- Note on/off
- Controllers
- System exclusive
- Engines MIDI channels
- Channel pointer

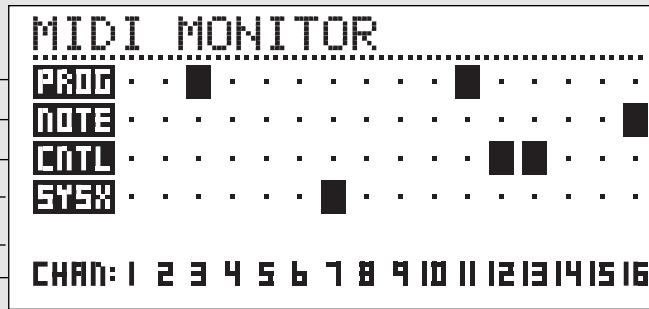

»TUNER SCREEN«

- Tuning guide
- Select guitar/bass or note set manual
- Master tune 440-445Hz

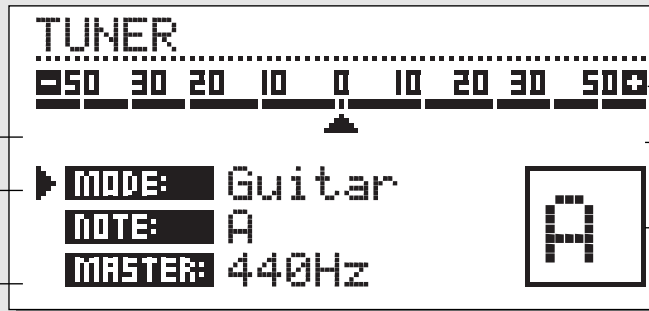

- Deviation in cents
- Tuning guide
- Detected note

MIDI Monitor

Press Shift - Util/Midi to access MIDI Monitor.

In the MIDI Monitor, you are able to see all MIDI actions received by the M2000. The actions are displayed according to the current channels.

- Prog. Displays Program changes.
- Note Displays Note On/Off.
- Cntl Displays Control changes
- Sys-x Displays System exclusive commands
- Eng Displays the midi channels of Eng 1,2 and combined.
- Chan Displays the Midi channels

Press any key to exit MIDI Monitor.

Tuner

Press Shift - Routing to access the Tuner of the M2000.

When Tuner is selected, the Outputs will be muted. Select Guitar/Bass/Manual mode by turning the ADJUST wheel. When Guitar or Bass is selected, the Tuner will only respond to notes corresponding to the strings of these instruments. When set to Manual, you must select the desired Note using the ADJUST wheel.

In the Master section, you can Calibrate the Tuners default, 440-445 Hz.

The detected note will be shown in the lower right corner and in the note line. When the horizontal marker is 0, you are tuned in. The two tuning guides will tell you whether the note is too flat or too sharp.

Press any key to exit Tuner.

EDIT

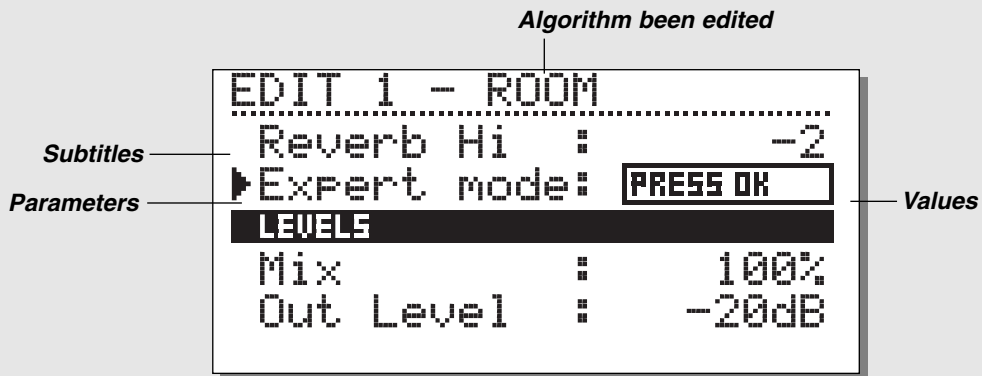

Edit

In the Edit menu, you always move by pressing the Cursor keys and change values by dialing the Adjust wheel.

Expert mode

When pressing OK on the Expert line, the M2000 will enable you to access a detailed Edit mode of the Reverbs.

Since the two different Edit modes (User & Expert) are not compatible, it is NOT possible to return to the User Edit mode. When Storing a preset Edited in Expert mode, the current preset will remain in expert mode forever.

Combined Edit

See illustration on next page

The relative Levels of the two Engines can be adjusted in this display. The range is: off - 0.0 dB.

These levels affect both analog and digital outputs.

Move the marker by pressing the Cursor keys; change values using the Adjust wheel.

The Engine Out Levels are identical with the Outlev. parameter in the Edit page and will, at all times, be corresponding with these.

DYNAMIC MORPHING

Dynamic Morphing

The Dynamic Morphing function is a great new way of interaction between your source signal and the Effect.

When activated, the M2000 will morph between the two Engines according to your Input level. This is a function for quick seamless changes of an Effect.

Think about the vocal in a ballad being soft and subtle during the verse and then rising to heartbreaking heights in the chorus. Now imagine the Reverb changing along with it, from a small discreet Room in the verse, to a Big Bright Hall in the chorus.

Simply select the two presets in the current Engines and then activate the Dynamic Morphing function. Set the Threshold and the Speed of the Dynamic Morphing and check out the result.



Morph direction 1-2:

If this box is selected, Engine 1 will be active while the Input is below Threshold.

Morph direction 2-1:

If this box is selected, Engine 2 will be active while the Input is below Threshold.

Note that the max. level of the Engines is set by the Engine Out bars above Dynamic Morphing.

The Dynamic Morphing is Stored along with Combined Presets.

The Dynamic Morphing function is only available when Routing is set to Parallel.

THE PROGRAMS

Reverb Programs

HALL-ROOM-PLATE-AMBIENCE-GATED

All Reverb presets both have a User and an expert page. The number of parameters depends on which preset you have selected.

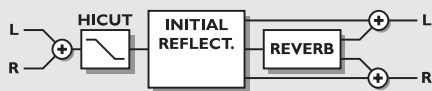

USER PARAMETERS

Decay

Sets the decay time. The value indicates the time to where the reverb tail is damped to -60dB.

Pre-delay

The time to arrival of the first reflection.

Reverb Lo

Adjust the low frequency reverberation time.

Reverb Mid

Adjust the mid frequency reverberation time.

Reverb Hi

Adjust the high frequency reverberation time.

Expert mode

Press OK here to enter expert mode. Remember there is no way back to normal user parameters, after adjusting any expert parameters.

HiCut freq.

Sets the cutoff frequency of the HighCut filter.

HiCut level

Damping ratio in dB of the HighCut filter.

Mix

Mix between direct and effect.

Out Level

Adjust output level. Use this parameter to match levels between presets.

EXPERT PARAMETERS

(only additional parameters mentioned)

Diffuse

This parameter sets the degree of wall diffusion. Increasing

the value will result in a more dense reverberation tail. Don't set the value too high, as it will result in a not natural sounding reverberation tail.

Room shape

Here you can choose between different room shapes.

Changing the room shape will change the initial reflections.

Size mult.

Size multiplication factor. With this parameter you can change the size of the room. Only the initial reflections are influenced by this factor.

Lo Crossover

Crossover frequency between low and mid band reverberation filter.

Mid Crossover

Crossover frequency between lo-mid and hi-mid band reverberation filter.

Hi Crossover

Crossover frequency between mid and high band reverberation filter.

Initial lev.

Sets the Initial reflection level.

Rev.lev.

Level of the reverberation tail.

Rev.width

This parameter adjust the stereo width of the reverb tail.

Rev Feed

Determines how fast the reverberation will build up.

Rev.diff

Imposes the characteristics of the early reflections on the later reverberation.

Distance

The relative distance control varies the mix relations between early and later reflections. Simulating how far away you are from the sound source.

Difusor type

The natural room mode peak frequencies and the smoothness of the tail are affected by this parameter.

Mod Rate

The MODRATE varies the rate of modulation of the recirculating delay paths simulating the reverb tail.

Mod Depth

Controls the amount of delay path modulation or "wander" in the reverb.

Chorus Programs

These presets are capable of producing a smooth natural sounding stereo chorus effect. The Hicut filter gives you the ability to make it sound very warm.

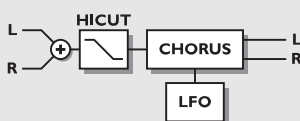

USER PARAMETERS

Speed

Controls the rate of sweep in a range from 1 sweep every 10 seconds to 10 sweeps every second.

Depth

Determines how wide a modulation (sweep) is produced.

Phase

Determines the sine wave modulation phase shift between left and right channels. At 0° the left and right modulation will move in sync. At 180° the modulation will move the channels against each other.

HiCut Freq.

Hicut shelving type filter (6dB/oct). This parameter sets the »hinge« point of the shelving filter.

HiCut Level

Sets maximum depth of cut above the HiCut shelving frequency.

Delay

Controls the length of delay time.

Mix

Mix between direct and effect.

Out Level

Adjust output level. Use this parameter to match levels between presets.

Flanger Programs

The Presets range from very soft add-on effects to the wildest guitar sound you can imagine. The Feedback filters are capable of controlling both high frequency and low frequency feedback.

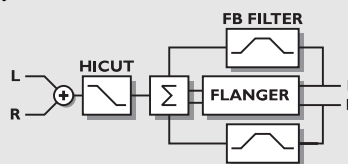

USER PARAMETERS

Speed

Controls the rate of sweep in a range from 1 sweep every 10 seconds to 10 sweeps every second.

Depth

Determines how wide a modulation (sweep) is produced.

Phase

Determines the sine wave modulation phase shift between left and right channels. At 0° the left and right modulation will move in sync. At 180° the modulation will move the channels against each other.

FB Level

Controls the amount of effect signal routed back to the flanger inputs. Select negative feedback to change feedback phase.

Delay

Controls the length of delay time.

FB HiCut

Feedback High Cutoff frequency. Signal is damped 6dB/oct above this frequency.

FB LoCut

Feedback Low Cutoff frequency. Signal is damped 6dB/oct below this frequency.

HiCut Freq.

(see chorus)

HiCut Level

(see chorus)

Mix

Mix between direct and effect.

Out Level

Adjust output level. Use this parameter to match levels between presets.

THE PROGRAMS... continued

Delay Programs

The Delay presets are capable of performing up to 1200 ms delay. The Feedback filters makes it possible to control both high and low frequency feedback.

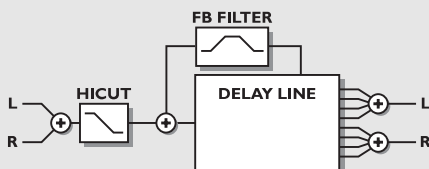

USER PARAMETERS

Delay

Controls the length of delay time.

FB Level

Controls the amount of effect signal routed back to the input.

FB HiCut

Feedback High Cutoff frequency. Signal is damped 6dB/oct above this frequency.

FB LoCut

Feedback Low Cutoff frequency. Signal is damped 6dB/oct below this frequency.

HiCut Freq.

Hicut shelving type filter (6dB/oct). This parameter sets the »hinge« point of the shelving filter.

HiCut Level

Sets maximum depth of cut above the HiCut shelving frequency.

Mix

Mix between direct and effect.

Out Level

Adjust output level. Use this parameter to match levels between presets.

Phaser Programs

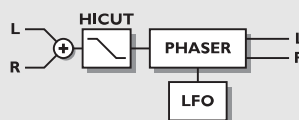

USER PARAMETERS

Intensity

Phaser intensity.

Speed

Controls the rate of sweep in a range from 1 sweep every 10 seconds to 10 sweeps every second.

Depth

Determines the depth of modulation.

HiCut Freq.

Hicut shelving type filter (6dB/oct). This parameter sets the »hinge« point of the shelving filter.

HiCut Level

Sets maximum depth of cut above the HiCut shelving frequency.

Mix

Mix between direct and effect.

Out Level

Adjust output level. Use this parameter to match levels between presets.

Multi Pitch-shift Programs

The Multi pitch presets are capable of performing 6 pitched Voices at the same time. This makes it possible to produce a true chorus effect.

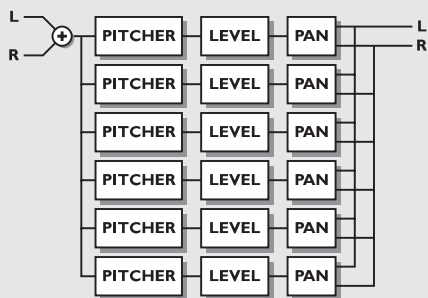

USER PARAMETERS

Mix

Mix between direct and effect.

Out Level

Adjust output level. Use this parameter to match levels between presets.

Voice

Sets which voice you are editing.

Pitch

Sets the pitch of the current Voice (0-1200).

Level

Sets the level of the current Voice.

Pan

Sets the panning of the current Voice.

Delay

Sets the Delay of the current Voice.

THE PROGRAMS... continued

EQ Programs

The EQ programs are all 3 band parametric types with separate high and low shelving bands.



USER PARAMETERS

Frequency

Low shelving filter ranges from 20hz to 5Khz

High shelving filter ranges from 500hz to 20Khz

Three band filters ranges from 20hz to 20Khz

Band width

Low and high shelving filters have 2 different bandwidths

The 3 bandfilters have 3 different bandwidths

Level

All filters range +/- 12dB.

EQ level

Adjustable +/-12dB.

Tremolo Programs

The Tremolo programs are effects where the output level is modulated by an LFO. Our programs are able of setting the LFO phase between the two outputs.

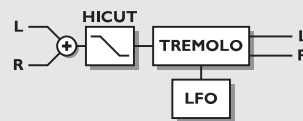

USER PARAMETERS

Speed

Controls the rate of sweep in a range from 1 sweep every 10 seconds to 10 sweeps every second.

Depth [intensity]

Determines how wide a modulation (sweep) is produced.

Phase

Determines the sine wave modulation phase shift between left and right channels. At 0° the left and right modulation will move in sync. At 180° the modulation will move the channels against each other.

Mix

Mix between direct and effect.

Out Level

Adjust output level. Use this parameter to match levels between presets.

Stereo Programs

USER PARAMETERS

Spatial

Controls the amount of spatial expansion.

HiCut Freq.

Hicut shelving type filter (12dB/oct). This parameter sets the »hinge« point of the shelving filter.

HiCut Level

Sets maximum depth of cut above the HiCut shelving frequency.

Mix

Mix between direct and effect.

Out Level

Adjust output level. Use this parameter to match levels between presets.

Dynamic Programs

COMPRESSOR-LIMITER-GATE-DE'ESSER

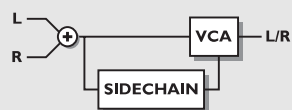

USER PARAMETERS

Attack

Dynamics attack time.

Release

Dynamics release time.

Ratio

Compression ratio.

Threshold (compressor)

Adjustable threshold level. The compressor will be engaged above this level.

Threshold (limiter)

Adjustable threshold level. The limiter will be engaged above this level.

Threshold (expander)

Adjustable threshold level. The expander is active below this level.

Gain (make-up gain)

The gain parameter compensates for the compression gain loss.

Deessing frequency

The de'essers attack frequency.

Deess damp

The damping ratio of unwanted »esses«.

THE RESET PAGE

Store and load your own
default settings

Enter UserData page

Reset system parameters

Clear all user presets

Test Programs

```

RESET
-----
▶ LOAD USER DEFAULT  OK
  STORE USER DEF.    OK
  SET USER NAME      OK
  RESET SYS PARAM.   OK
  CLEAR ALL PRESETS  OK
  RUN TEST PROGRAM   OK
    
```

Type your name here

and your phone number

```

USER DATA
-----
▶ NAME: Albert E
  PHONE: 123456789
  
```

C		A	B	C	D	E	F	G	H	I	J	K	L	M	N
▶	0	P	Q	R	S	T	U	V	W	X	Y	Z	[]	3
▶	4	5	6	7	8	9	0	-	+	:	←	→	CODE		

Place cursor here
and press OK to
finalize session.

How to enter the Reset page:

Hold one of the 3 Bypass keys pressed while power-up.

Move the marker using the Cursor keys and press OK to select the RESET type you desire.

Load User Default

This will reset all system parameters back to a Default setup made by you (See Store User Def). This reset will NOT delete the User presets of the M2000.

Store User Def

When you have a perfect setup of your M2000, you are able to Store this as your own Default setup. This function is very useful, for example when you have finished a special production and want to go back to normal. When you have the perfect setup of your M2000, simply select this parameter and press OK to store your Default settings.

Set User Name

This function makes it possible to write your Name and Phone number into the M2000. Press OK to access the User data menu. Use the ADJUST wheel and the Cursor keys to write your Name and Phone number into the M2000. Press OK to accept. Your Name and Phone number will be displayed during power-up.

Reset System Parameters

This will reset all system parameters back to the Factory Default. This reset will NOT delete the User presets of the M2000.

Reset all Presets

This will Clear all Ram Presets .

TECHNICAL SPECIFICATIONS

Digital Inputs and Outputs

Connectors:	XLR (AES/EBU), RCA Phono (S/PDIF)
Formats:	AES/EBU (24 bit), S/PDIF (20 bit), EIAJ CP-340, IEC 958
Output Dither:	HPF TPDF dither 8 to 24 bit
Sample Rates:	32 kHz, 44.1 kHz, 48 kHz
Processing Delay:	0.2 ms @ 48 kHz
Frequency Response DIO:	DC to 23,9 kHz \pm 0,01 dB @ 48 kHz

Analog Inputs

Connectors:	XLR balanced (pin 2 hot)
Impedance:	20 kohm
Max. Input Level:	+22 dBu (balanced)
Min. Input Level (for 0 dBFS):	-10 dBu
Sensitivity:	@ 12 dB headroom: -22 dBu to +10 dBu
A to D Conversion:	24 bit (1 bit, 128 times oversampling)
A to D Delay:	0.8 ms @ 48 kHz
Dynamic Range:	>103 dB (unweighted), >106 dB(A)
THD:	-95 dB (0,0018 %) @ 1 kHz, -6 dBFS (FS @ +16 dBu)
Frequency Response:	10 Hz to 20 kHz: +0/-0.2 dB
Crosstalk:	<-80 dB, 10 Hz to 20 kHz, typical -100 dB @ 1 kHz

Analog Outputs

Connectors:	XLR balanced (pin 2 hot)
Impedance:	100 ohm (active transformer)
Max. Output Level:	+22 dBu (balanced)
Full Scale Output Range:	-10 dBu to +22 dBu
D to A Conversion:	24 bit (1 bit, 128 times oversampling)
D to A Delay:	0.57 ms @ 48 kHz
Dynamic Range:	>100 dB (unweighted), >104 dB(A)
THD:	-86 dB (0.005 %) @ 1 kHz, -6 dBFS (FS @ +16 dBu)
Frequency Response:	10 Hz to 20 kHz: +0/-0.5 dB
Crosstalk:	<-60 dB, 10 Hz to 20 kHz, typical -90 dB @ 1 kHz

EMC

Complies with: EN 55103-1 and EN 55103-2 FCC part 15, Class B. CISPR 22, Class B

Safety

Certified to: IEC 65, EN 60065, UL 1419, CSA E65

Environment

Operating Temperature: 32° F to 122° F (0° C to 50° C)
 Storage Temperature: -22° F to 167° F (-30° C to 70° C)
 Humidity: Max. 90 % non-condensing

PCMCIA Interface

Connector: PC Card, 68 pin type 1 cards
 Standards: PCMCIA 2.0, JEIDA 4.0
 Card Format: Supports up to 2 MB SRAM

Control Interface

MIDI: In/Out/Thru: 5 Pin DIN
 GPI, Pedal, Fader: 1/4" phone jack, 0 ohm to 50 kohm

General

Finish: Anodized aluminum front, Plated and painted steel chassis
 Dimensions: 19" x 1.75" x 8.2" (483 x 44 x 208 mm)
 Weight: 5.2 lb. (2.35 kg)
 Mains Voltage: 100 to 240 VAC, 50 to 60 Hz (auto-select)
 Power Consumption: <20 W
 Backup Battery Life: >10 years
 Warranty Parts and labor: 1 year

TROUBLESHOOTING

You press the POWER switch but there is no light.

- The power switch on the rear panel is switched off.

The input PPM meters don't peak out.

- You are using analog inputs, but the input selector in the I/O menu is set to digital in.
- The analog input level is set too low.

Only left input PPM meter is showing a signal.

- Set input selector (in I/O menu) to *Both*

No sound through the M2000.

- You are using analog inputs, but the input selector in the I/O menu is set to digital in.

You can't turn the power off.

- Hold the power switch pressed for at least 3 seconds.

All Program sounds »phased«

- You are using the M2000 in combination with a mixing console (send/return), but have not set Mix to 100%. You can do this permanently in the I/O menu.

Pedal works wrong

- Be sure the pedal is a »make« type.

MIDI IMPLEMENTATION CHART

STUDIO EFFECTS PROCESSOR M2000 - FEB 2, 1996 Version 1.0

Function		Transmitted	Recognized	Remarks
Basic Channel	Default	1-3	1-3	Eng1: 1, Eng2: 2, Com: 3
	Changed	1-16	1-16	
Mode	Default			
	Messages	X	X	
	Altered			
Note Number		X	X	
	True Voice	X	X	
Velocity	Note ON	X	X	
	Note OFF	X	X	
After Touch	Key's	X	X	
	Ch's	X	X	
Pitch Bend		X	X	
Control Change		from 10 and up	from 10 and up	Cntl.#10: Mix (If available) Cntl.#11: Output Level Cntl.#12: First Param. on Edit page. Cntl.#13: Second Param. on Edit page. Cntl.#14: Third Cntl.#15: ... Cntl.#16: ... Cntl.#17: ...
<i>All Controllers are single byte type, scaled to parameter range.</i>				
Prog Change		O	O	
	True#	0-127	0-127	
System Exclusive		O	O	
Common	:Song Pos	X	X	
	:Song Sel	X	X	
	:Tune	X	X	
System real time	:Clock	O	O	
	:Commands	X	X	
Aux Messages	:Local ON/OFF	X	X	
	:All Notes OFF	X	X	
	:Active Sense	X	X	
	:Reset	X	X	

Notes

O: YES Mode1: OMNI ON, POLY Mode 2: OMNI ON, MONO
X: NO Mode 3: OMNI OFF, POLY Mode 4: OMNI OFF, MONO

SELF TEST

PRESS ONE OF THE 3 BYPASS KEYS, WHILE POWERING UP, TO ACCESS THE SELF-TEST AND SELECT »RUN TEST PROGRAM«

Turn the Adjust Wheel to scroll through Self tests

Key test

Select Key test by pressing OK.
The keys must be pressed in the order they are requested by the M2000 to pass the test.
Press Cancel to exit Key test.

Adjust Wheel test

Select Adjust Wheel test by pressing OK
Turn the Adjust Wheel to 30 and back to 0 to pass test.
Press Cancel to exit Adjust Wheel test.

Led test

Select Led test by pressing OK
Turn Adjust Wheel to test the Leds. The test is "ok" when all Leds are lit.
Press Cancel to exit Led test.

Display test

Select Display test by pressing OK
Press OK to check that all pixels are lit. Press any key to leave the pixel test.
Press Cancel to exit Display test.

Analog I/O test

Select Analog I/O test by pressing OK
Connect an Analog Output to the Analog Input, which has to be tested and press OK.
Use a balanced cable.
PPM must show -12 dB to pass test.
Press Cancel to Exit Analog I/O test

Digital I/O test

Select Digital I/O test by pressing OK
Connect a Digital Output to the Digital Input, which has to be tested and press OK.
The AES/EBU output can also be connected to the S/PDIF input and vice versa.
PPM must show 0 dB to pass test.
Press Cancel to exit Digital I/O test.

Midi I/O test

Select Midi I/O test by pressing OK
Connect Midi Out to Midi In.
Prg change 1-128 is send out on Midi Thru. Connect this socket to a Midi compatible device and confirm the Prg. changes.
Press Cancel to exit Midi I/O test.

Pedal test

Select Pedal test by pressing OK.
Connect a momentary pedal to the Pedal socket.
When pressing the Pedal, the Result should be OK.
When released, the Result should be Not OK.
Press Cancel to Exit Pedal test.

PCMCIA test

Select PCMCIA test by pressing OK
Insert PCMCIA card. Note that all Data on PCMCIA card will be destroyed.
Press OK to test.
Result reads:
Low battery - Time to change battery in your PCMCIA card.
Not Ok - Try the test using another PCMCIA card.
Press Cancel to Exit PCMCIA test.

Battery test

Select Battery test by pressing OK
Confirm that Result is "ok".
Press Cancel to Exit Battery test.

System test

Select System test by pressing OK
Confirm that Result is "ok".
Result reads:
Eeprom Not ok - The unit will most likely work ok, the message is for service matters only.
DSP Not ok - Contact your local dealer.
Press Cancel to Exit System test.

Power Off - On to start standard software.

GLOSSARY

AES/EBU

Professional digital in/out standard, using balanced XLR cables.

S/PDIF

Consumer digital in/out standard, normally using coaxial phono-type cables.

DITHERING

Dithering is a method to optimize the quality of a digital audio signal at low levels. A small amount of filtered noise is added to the signal, giving you a less distorted low level signal.

If you are using digital outputs, the equipment you feed determines the number of bits. A DAT recorder should always be dithered to 16 bit.

PROF/CONS LEVELS

Depending on which equipment you are using along with the M2000, you must set the PRO/CON parameters correctly in the I/O setup menu.

M2000 Analog Inputs:

Consumer range: -16dB to +10dB, nominal level = -10dB

Professional range: -6dB to +16dB, nominal level = +4dB

M2000 Analog Outputs:

Consumer range: -10dB to +16dB

Professional range: -16dB to +6dB

The levels are either listed in the technical specifications or printed on the rear panel of the connected devices.

DE'ESSING

An algorithm that removes unwanted »esses« from a vocal material.

SYSTEM EXCLUSIVE MIDI COMMANDS

Device-dependent MIDI commands, normally used for remote controlling machines.

PRESET LIST - SINGLE PRESETS

- | | | | | | |
|----|------------------------|----|----------------------|-----|----------------------|
| 1 | M2000 Hall | 48 | Tiled Room | 95 | Guitar Compressor |
| 2 | Great Vocal Hall | 49 | Small Room for Drums | 96 | Light Compressor |
| 3 | Very Big Hall | 50 | Percussion Room | 97 | Heavy Compressor |
| 4 | Warm MidSize Hall | 51 | Long Gold Plate | 98 | Gain Maximizer |
| 5 | Bright MidSize Hall | 52 | Medium Gold Plate | 99 | Pumpin Compressor |
| 6 | Small Hall | 53 | Short Gold Plate | 100 | Heavy Limit |
| 7 | Nice Hall | 54 | Large Bright Plate | 101 | Limiter |
| 8 | Realistic Hall | 55 | Snare Plate | 102 | Fast Gate |
| 9 | Chorus Reverb | 56 | Vocal dry | 103 | Slow Gate |
| 10 | Synthesizer Reverb | 57 | Vocal Wet | 104 | Expander |
| 11 | Soundcheck Empty Arena | 58 | Air | 105 | Program De-Esser |
| 12 | High School gym | 59 | Microphone Bleed | 106 | Vocal De-Essing |
| 13 | Empty Theater | 60 | Small Studio Room | 107 | Hard De-Essing |
| 14 | Airport Gate | 61 | Small Box Ambience | 108 | Neutral EQ |
| 15 | Big Church | 62 | Tiled Staircase | 109 | Bass EQ |
| 16 | Arvo Part Cathedral | 63 | Nextdoor | 110 | Acoustic Guitar EQ |
| 17 | Taj Mahal | 64 | Living Room | 111 | Loudness |
| 18 | Big Snare Hall | 65 | Phonebooth | 112 | Turn up the Bass |
| 19 | Vintage Hall | 66 | Inside a Locker | 113 | Air EQ |
| 20 | Wood Floor | 67 | Inside a Van | 114 | Telephone Voice |
| 21 | Stone Wall | 68 | Tunnel | 115 | Voice Multipitch |
| 22 | Doubling Room | 69 | ZigZag Perc effect | 116 | 6-Voice Bass Pitch |
| 23 | SlapBack Room | 70 | Triple slap Reverb | 117 | 6-Voice Guitar Pitch |
| 24 | Sidewall Reflections | 71 | Gated Reverb Short | 118 | Fifths Up and Down |
| 25 | Backwall Reflections | 72 | Gated Reverb Medium | 119 | Barbershop |
| 26 | True Room | 73 | Gated Reverb Long | 120 | Mono to Stereo |
| 27 | Home Room | 74 | Gated Hall | 121 | Expanded Mono |
| 28 | The Shop | 75 | Gated Room | 122 | Casual Panner |
| 29 | The CORE Room | 76 | Gated Gold Plate | 123 | Straight Slow Panner |
| 30 | At Home | 77 | Straight Delay | 124 | Fast Narrow Panner |
| 31 | New Booth | 78 | Soft Delay | 125 | Slow Tremolo |
| 32 | Large Room | 79 | Slapback Delay | 126 | Fast Tremolo |
| 33 | Medium Room | 80 | The King Vocal Delay | 127 | Very Fast Tremolo |
| 34 | Small Room | 81 | Delay Doubler Effect | 128 | No Effect |
| 35 | Very Small Room | 82 | Old Tape Echo | | |
| 36 | Small Wood Room | 83 | Metallic Delay | | |
| 37 | Small damped Room | 84 | In a Tin Can | | |
| 38 | Empty Room | 85 | Plain Chorus | | |
| 39 | Small Chamber | 86 | Center Chorus | | |
| 40 | Very Small Chamber | 87 | Chorus Extreme | | |
| 41 | Dark Chamber | 88 | Stereo Flange | | |
| 42 | Locker Room | 89 | Talking Flange | | |
| 43 | Auditorium | 90 | Dark Flanger | | |
| 44 | Basement | 91 | Phaser 1 | | |
| 45 | Empty Garage | 92 | Phaser 2 | | |
| 46 | In the Bathroom | 93 | Phaser 3 | | |
| 47 | Classroom | 94 | Vocal Compressor | | |

PRESET LIST - COMBINED PRESETS

- | | | | | | |
|----|----------------------|----|----------------------|-----|-----------------------|
| 1 | Two 2000 Halls | 48 | Slapdelay along Hall | 95 | Slapdelay in Circles |
| 2 | Deep Room | 49 | Slapdelay + Gateverb | 96 | Doubler and Panner |
| 3 | Smooth Hall | 50 | Room + Long Delay | 97 | Panned Inverse |
| 4 | Small warm Hall | 51 | Very Long Delay-Verb | 98 | Slow Moving Reverb |
| 5 | Giant Hall | 52 | Right and Left | 99 | In Cirkles |
| 6 | Thick Drum Room | 53 | Subtle Slap | 100 | Two Panners |
| 7 | Thick Gated Reverb | 54 | Clean Arpeggio | 101 | True Stereo Delay |
| 8 | Big Drum Hall | 55 | Tap Dance Delay | 102 | Stereo Garage |
| 9 | Two Verbs | 56 | Fast Flanged Delay | 103 | Stereo EQ |
| 10 | Warm and Slow | 57 | Nice Pitch + Delay | 104 | Stereo Compressor |
| 11 | Short + Slow Reverb | 58 | Bright Delay | 105 | Stereo Limiter |
| 12 | Big and Warm Hall | 59 | Two Delays | 106 | Stereo Gate |
| 13 | Nice Big Hall | 60 | Thick Delay | 107 | Short Stereo Delay |
| 14 | Reverb along Reverb | 61 | Telephone Delay | 108 | True Stereo Reverb |
| 15 | Chorus-like Hall | 62 | Slpabacking Flanger | 109 | Insert Compressors |
| 16 | Warm Vintage Hall | 63 | Slapback and Doubler | 110 | Insert EQs |
| 17 | Fat Hall | 64 | Chorus + Delay | 111 | Insert Gates |
| 18 | Flanged Hall | 65 | Beautiful SpaceDelay | 112 | Echo in the Basement |
| 19 | Chorused Hall | 66 | Slow Reverb + Delay | 113 | Dynamic Flanger |
| 20 | Chorused Stonewall | 67 | Echo Chorus | 114 | Vocalroom-Choruslike |
| 21 | Big Lead Guitar | 68 | Slowflange and Echos | 115 | Short-Long Reverb |
| 22 | Reverb + MultiPitch | 69 | Fizzy Echoes | 116 | Compressor-Reverb |
| 23 | Realistic Room | 70 | Compressed Flanger | 117 | Bright -Warm Reverb |
| 24 | Reverb in Reverb | 71 | Comp + Gated Verb | 118 | Warm-Bright Reverb |
| 25 | Biig Room | 72 | Comp+ Small Drumhall | 119 | Chorus-Chorus |
| 26 | Short Room | 73 | Compressed Snarehall | 120 | Dynmorph Looong Room |
| 27 | Light Medium Room | 74 | Compressed Room | 121 | Hall-Ambience |
| 28 | Double Room | 75 | Compressed + Hall | 122 | Slapdelay-Vocal Wet |
| 29 | Flanged Small Room | 76 | Vocal Comb + Delay | 123 | Delay-SlapDelay |
| 30 | Flanged Ambience | 77 | De-essed Delay | 124 | Dynmorph SneakingVerb |
| 31 | Flanged Room | 78 | De-Essed M2000 Hall | 125 | Delay-Reverb |
| 32 | Open up the Vocal | 79 | De-Essed Bright Hall | 126 | Reverb-Delay |
| 33 | All Ambience | 80 | De-Essed Basement | 127 | Changing Ambience |
| 34 | Far Away | 81 | De-Essed Ambience | 128 | Blues in a Room |
| 35 | Chorused Room | 82 | Heavy Limit+Expander | | |
| 36 | Sing in the Shower | 83 | De-Esser + EQ | | |
| 37 | Nice wide Vocal | 84 | Compressor+De-esser | | |
| 38 | Wide Room | 85 | Limiter + EQ | | |
| 39 | Chorused Ambience | 86 | Compressor + Expand | | |
| 40 | Room Multiplied | 87 | Compressor + Limiter | | |
| 41 | A litle to the Right | 88 | Vocal Compressor+EQ | | |
| 42 | Wobbly Hall | 89 | LeslieLike Rotor | | |
| 43 | Multiplex Hall | 90 | Panned Delay | | |
| 44 | Chorus Doubler | 91 | Slow Panned Phone | | |
| 45 | Ultimative Chorus | 92 | Moving Ambience | | |
| 46 | Unchained Flanger | 93 | Moving Vintage Hall | | |
| 47 | The King | 94 | Autopanned Stonewall | | |